

-0,080 As верхня по X

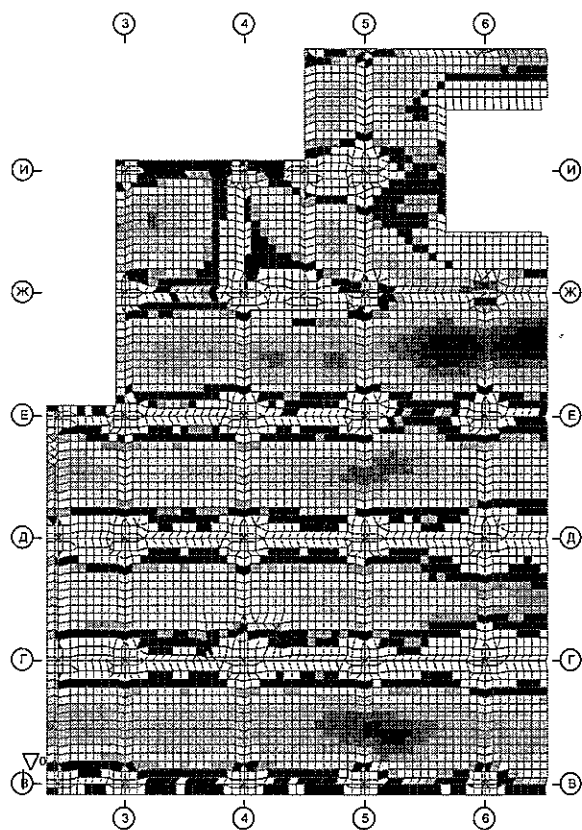

0	0.29
0.29	0.59
0.59	0.88
0.88	1.18
1.18	1.47
1.47	1.77
1.77	2.06

2.06	2.36
2.36	2.65
2.65	2.95
2.95	3.24
3.24	3.53
3.53	3.83
3.83	4.12

-0,080 As нижняя по У

8

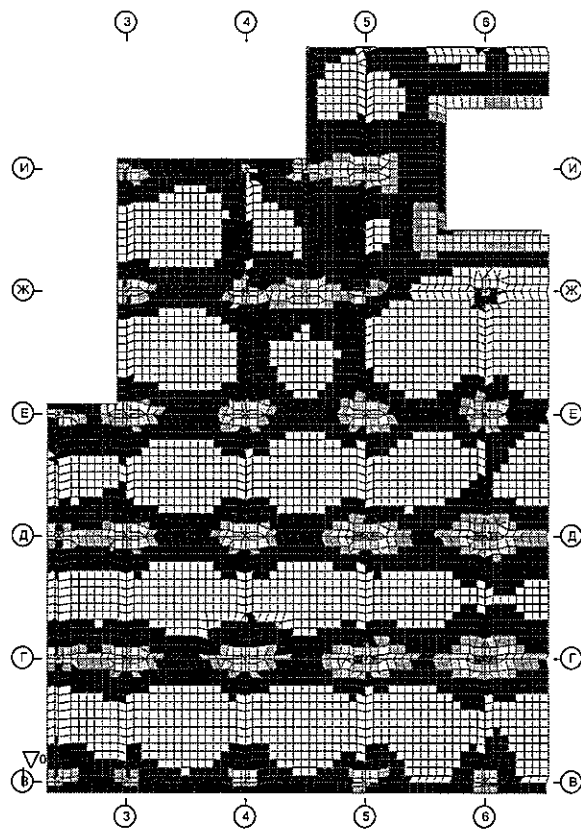

0 1.04
1.04 2.07
2.07 3.11
3.11 4.15
4.15 5.19
5.19 6.22
6.22 7.26

7.26 8.3
8.3 9.33
9.33 10.37
10.37 11.41
11.41 12.44
12.44 13.48
13.48 14.52

-0,080 Ас верхняя по У

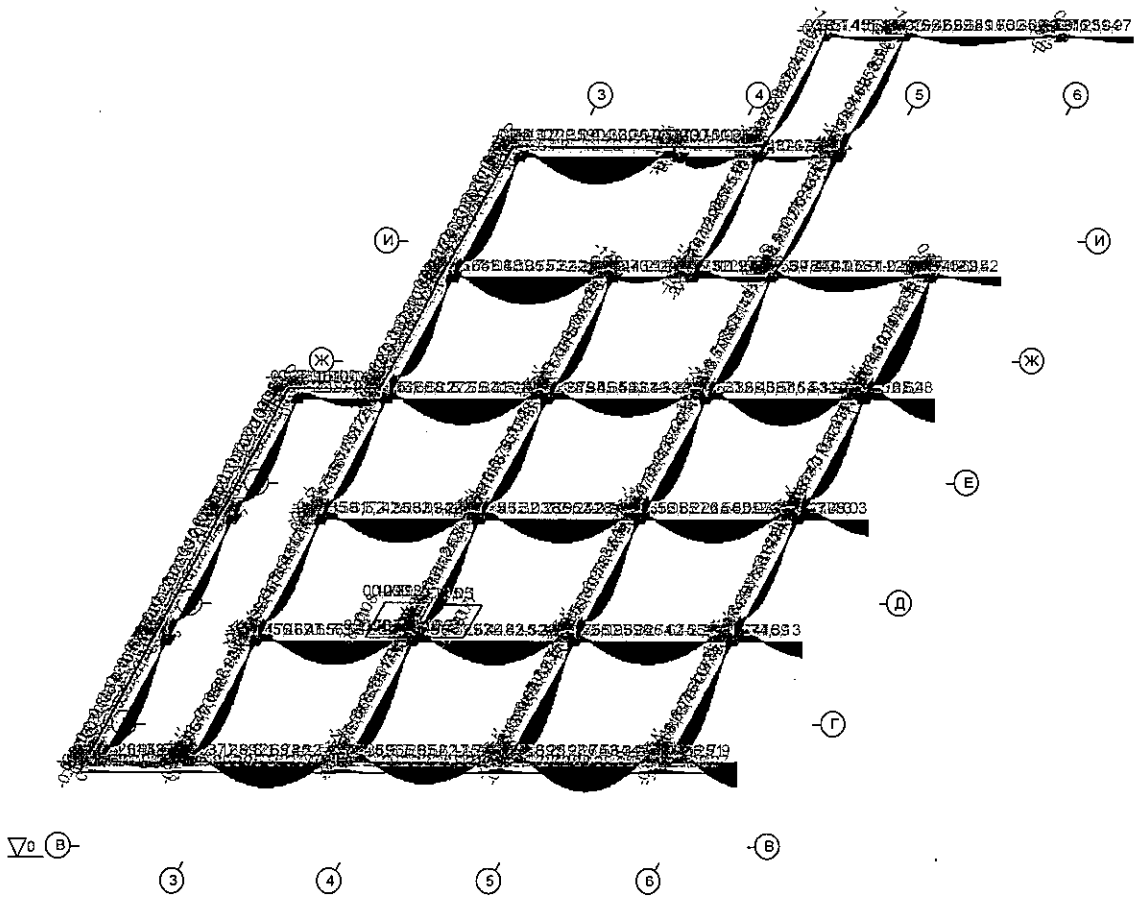

-0,080 My



∇в Б

Б

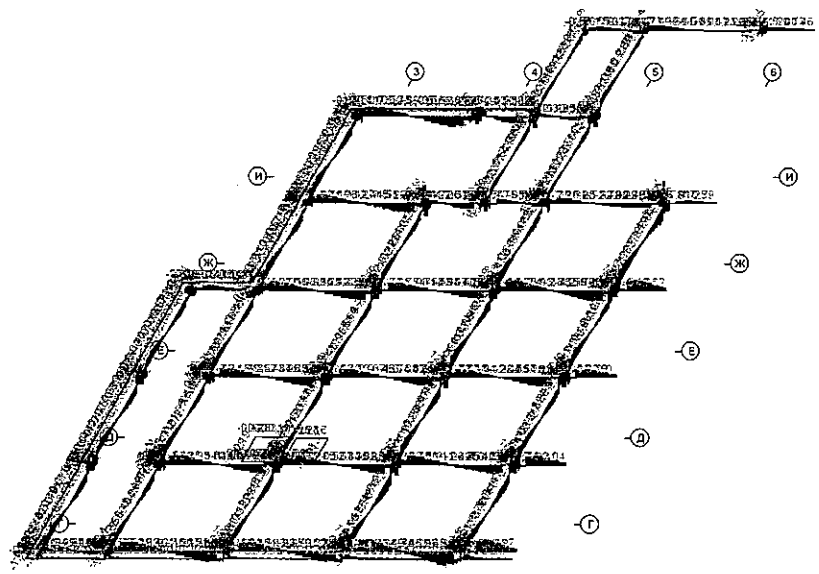

∇_0 ③ ④ ⑤ ⑥ ⑥

-0,080 Qz

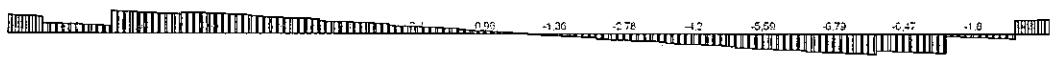

∇_0 ③ ④

⑥ ⑥

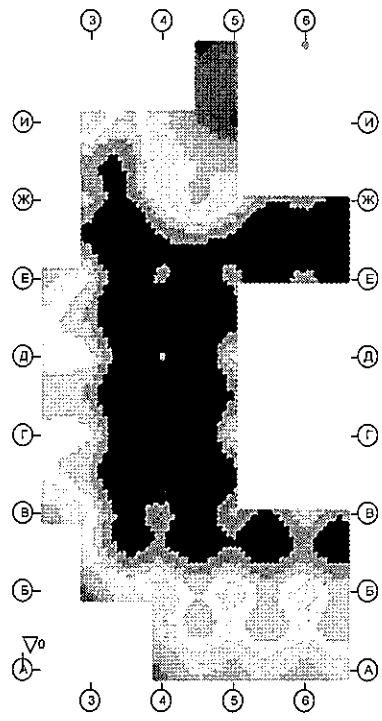

Перемещение Z (мм). Комбинация 1 (L1)*1+(L2)*1+(L3)*1

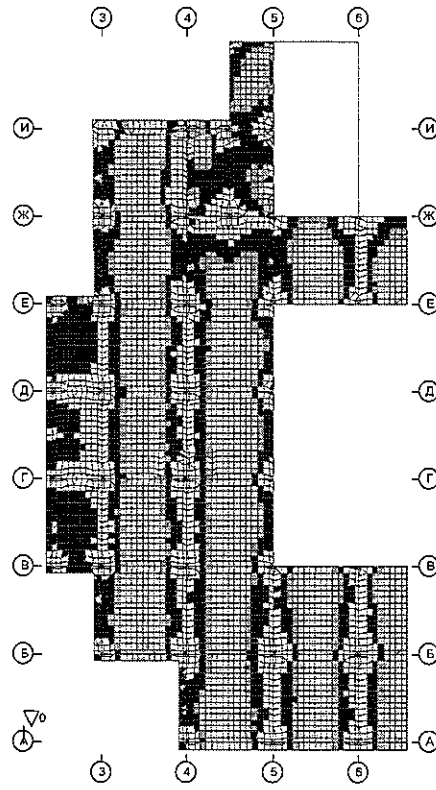

0	0.41
0.41	0.82
0.82	1.22
1.22	1.63
1.63	2.04
2.04	2.45
2.45	2.85

2.85	3.26
3.26	3.67
3.67	4.08
4.08	4.49
4.49	4.89
4.89	5.3
5.3	5.71

+3,820 As нижняя по X

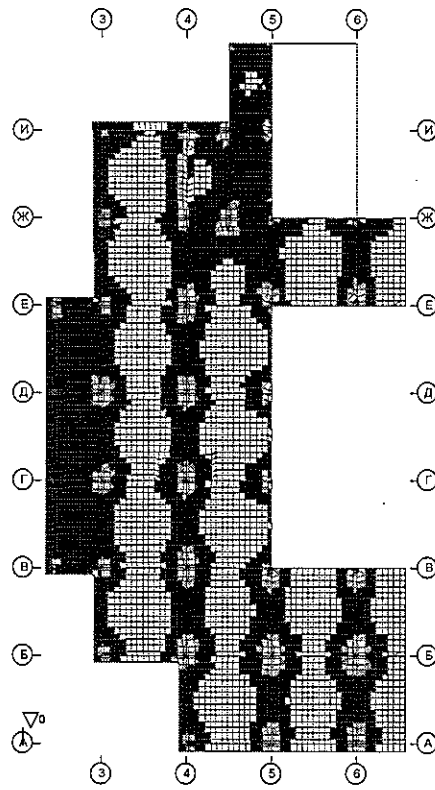

0	1.17
1.17	2.34
2.34	3.51
3.51	4.68
4.68	5.84
5.84	7.01
7.01	8.18

8.18	9.35
9.35	10.52
10.52	11.69
11.69	12.86
12.86	14.03
14.03	15.19
15.19	16.36

+3,820 As верхняя по X

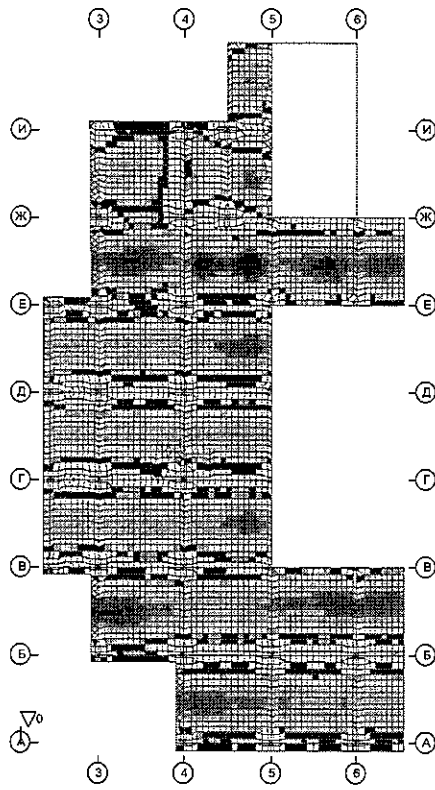

0	0.25
0.25	0.5
0.5	0.76
0.76	1.01
1.01	1.26
1.26	1.51
1.51	1.77

1.77	2.02
2.02	2.27
2.27	2.52
2.52	2.77
2.77	3.03
3.03	3.28
3.28	3.53

+3,820 As нижняя по У

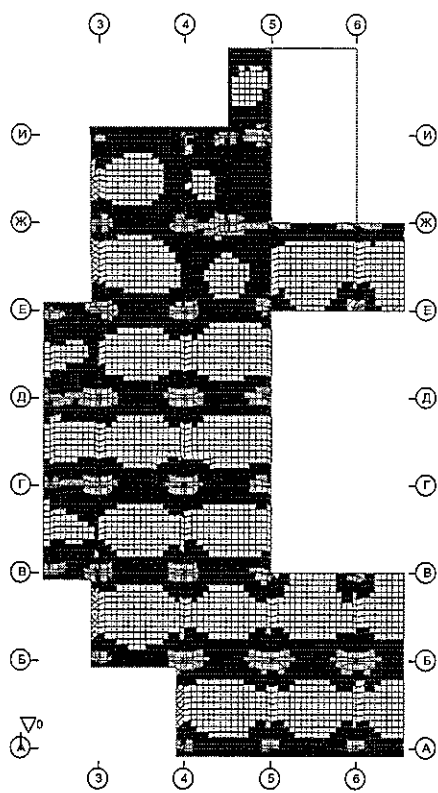

0	1.27
1.27	2.53
2.53	3.8
3.8	5.07
5.07	6.34
6.34	7.6
7.6	8.87

8.87	10.14
10.14	11.41
11.41	12.67
12.67	13.94
13.94	15.21
15.21	16.48
16.48	17.74

+3,820 As верхняя по У